

weather guard[®]

SECURE EVERY CHALLENGE[™]



TRUCK STORAGE EQUIPMENT

THE FUTURE OF TRUCK BOXES IS HERE.



weather guard[®]

Your truck and tools are everything to your livelihood. That's why real pros know there's only one name they can trust, WEATHER GUARD[®]. The new line of WEATHER GUARD[®] truck boxes convert your truck into a sleek mobile fortress, with superior anti-theft construction and locks able to withstand any weather condition or attempted theft.

SECURE EVERY CHALLENGE.[™]

WEATHERGUARD.COM

TABLE OF CONTENTS

WEATHER GUARD® TRUCK BOXES	4	Service Body Ladder Racks	23
Saddle Boxes	4	Accessories	24
Lo-Side Boxes	6	WEEKENDER® Truck Rack	25
Hi-Side Boxes	8	Truck Rack Fit Guide	26
Super-Side Boxes	10	Steel Cab Protectors and Accessories	27
Gull Wing Boxes	11	IN-BED STORAGE SOLUTIONS	28
All-Purpose Chests	12	PACK RAT® Drawer Units	28
Wheel Well Boxes	14	Transfer Tanks/Accessories	30
Truck Box Accessories	15	UNDERBED BOXES	32
Truck Box Fitment Guide	16	Steel Underbed Boxes	32
BED-RAIL MOUNTED SOLUTIONS	18	Aluminum Underbed Boxes	33
Aluminum Headache Rack	18	NOTES	34
Aluminum Headache Rack Fitment	20		
Steel Truck Rack	21		

CODING THE LOCKS* EASY 3-STEP GUIDE

1

OPEN THE BOX LID & INSERT THE KEY

Code multiple boxes on a truck or entire fleet to the same key



2

ROTATE KEY A FULL 3/4 OF A CIRCLE

During key coding, there WILL be resistance. Continue through rotation.



3

REMOVE KEY

The lock is now permanently coded. Make sure to register your key code.



* For -04 Saddles & Lo-Sides Only

UNMATCHED PROTECTION SADDLE BOXES

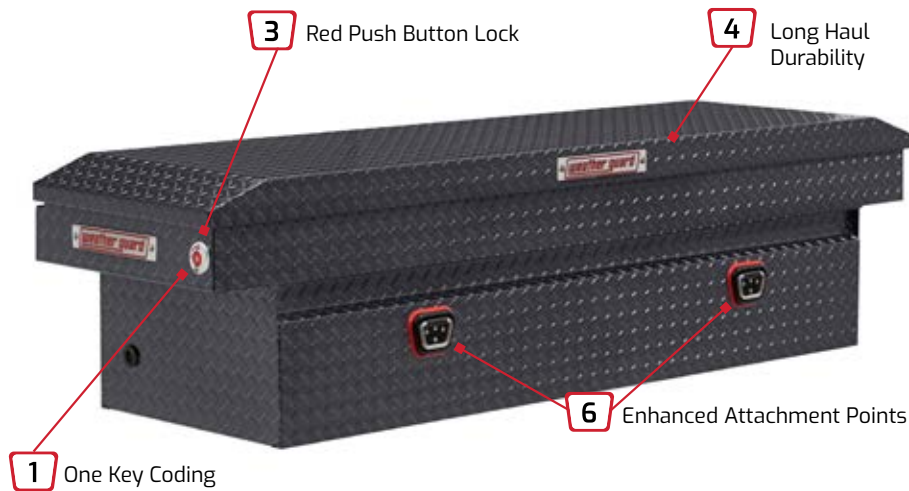

1 One Key Coding



5 Superior Weather Resistance



6 Enhanced Attachment Points

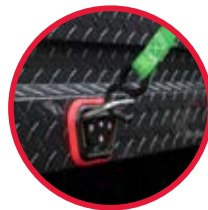

THE ULTIMATE IN PROTECTION

Maximum Durability

- 1 ONE KEY CODING**
Code multiple boxes on one truck or an entire fleet to work with the same key
- 2 TOP SECURITY PROTECTION**
Automotive-grade lock-and-latching system
- 3 RED PUSH BUTTON LOCK**
See when your box is locked or unlocked for peace of mind
- 4 LONG HAUL DURABILITY**
ARMOR TUF® powder coat for long-lasting performance and looks
- 5 SUPERIOR WEATHER RESISTANCE**
Precision fit weather stripping for tight seal
- 6 ENHANCED ATTACHMENT POINTS**
Wide clearance and added rivets for more straps and reinforced anchor points

LIFETIME LIMITED WARRANTY

WEATHER GUARD® IS THE ULTIMATE IN PROTECTION OF SADDLE BOXES

Like you, WEATHER GUARD® Saddle Boxes keep getting better and better. Now with more options and features than ever. Like industry-leading security with our exclusive tamper-resistant EXTREME PROTECTION™ LOCK. WEATHER GUARD® Saddle Boxes are the most popular truck storage option due to ease of installation, maximum bed clearance, and of course legendary durability. Constructed of either steel or aluminum diamond plate and finished with an ARMOR TUF® Powder Coat that lasts for years and looks great.

ALUMINUM DIAMOND PLATE



Clear ARMOR TUF®
Powder Coat



Textured Matte Black
ARMOR TUF®
Powder Coat



Gloss Black
ARMOR TUF®
Powder Coat



Gunmetal Gray
ARMOR TUF®
Powder Coat

STEEL



Brite White
ARMOR TUF®
Powder Coat



Gloss Black
ARMOR TUF®
Powder Coat

Choice Options: X = 0 (Clear) or X = 3 (Brite White) or X = 5 (Gloss Black) or
X = 52 (Textured Matte Black) or X = 6 (Gunmetal Gray)





FULL-SIZE STANDARD

- ALUMINUM 11.0 CUBIC FEET**
- 127-0-04 127-52-04
 - 127-5-04 127-6-04

Ship Weight: 80 Lbs.

- STEEL 11.0 CUBIC FEET**
- 126-3-04
 - 126-5-04

Ship Weight: 123 Lbs.



FULL-SIZE EXTRA WIDE

- ALUMINUM 15.5 CUBIC FEET**
- 117-0-04 117-52-04
 - 117-5-04 117-6-04

Ship Weight: 102 Lbs.

- STEEL 15.5 CUBIC FEET**
- 116-3-04
 - 116-5-04

Ship Weight: 168 Lbs.



FULL-SIZE LOW PROFILE

- ALUMINUM 11.0 CUBIC FEET**
- 121-0-04 121-52-04
 - 121-5-04 121-6-04

Ship Weight: 81.5 Lbs.

- STEEL 11.0 CUBIC FEET**
- 120-3-04
 - 120-5-04

Ship Weight: 138 Lbs.



FULL-SIZE EXTRA DEEP

- ALUMINUM 15.0 CUBIC FEET**
- 123-0-04 123-52-04
 - 123-5-04 123-6-04

Ship Weight: 90 Lbs.

- STEEL 15.0 CUBIC FEET**
- 128-3-04
 - 128-5-04

Ship Weight: 156 Lbs.

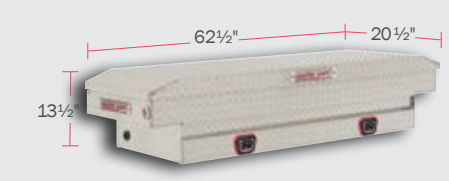

COMPACT STANDARD

- ALUMINUM 7.0 CUBIC FEET**
- 154-0-04 154-52-04
 - 154-5-04 154-6-04

Ship Weight: 69.5 Lbs.

- STEEL 7.0 CUBIC FEET**
- 156-3-04
 - 156-5-04

Ship Weight: 117 Lbs.



COMPACT LOW-PROFILE

- ALUMINUM 8.0 CUBIC FEET**
- 131-0-04 131-52-04
 - 131-5-04 131-6-04

Ship Weight: 72 Lbs.

- STEEL 8.0 CUBIC FEET**
- 130-3-04
 - 130-5-04

Ship Weight: 117 Lbs.



COMPACT DEEP

- ALUMINUM 9.0 CUBIC FEET**
- 137-0-04 137-52-04
 - 137-5-04 137-6-04

Ship Weight: 76 Lbs.

- STEEL 9.0 CUBIC FEET**
- 136-3-04
 - 136-5-04

Ship Weight: 117 Lbs.

UNMATCHED PROTECTION LO-SIDE BOXES

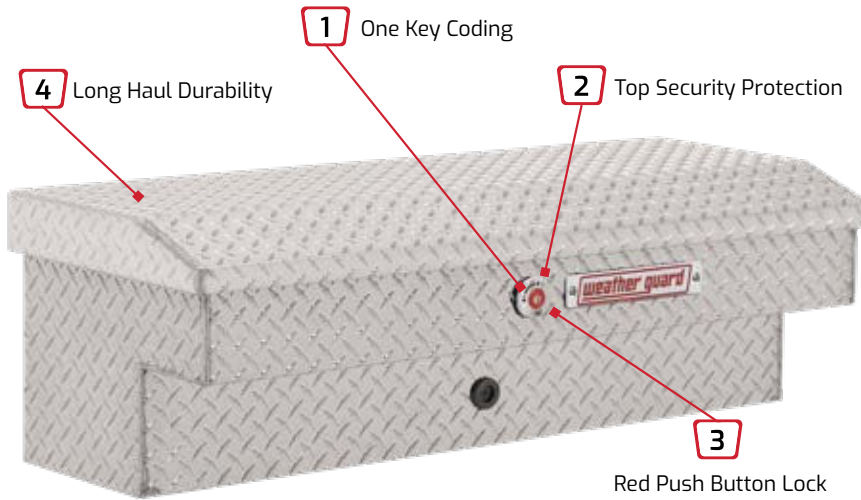

LO-SIDE BOXES KEY FEATURES

- 1 ONE KEY CODING**
Code multiple boxes on one truck or an entire fleet to work with the same key
- 2 TOP SECURITY PROTECTION**
Automotive-grade lock-and-latching system
- 3 RED PUSH BUTTON LOCK**
See when your box is locked or unlocked for peace of mind
- 4 LONG HAUL DURABILITY**
ARMOR TUF® powder coat for long-lasting performance and looks
- 5 SUPERIOR WEATHER RESISTANCE**
Precision fit weather stripping for tight seal
- 6 ENHANCED ATTACHMENT POINTS**
Wide clearance and added rivets for more straps and reinforced anchor points



LIFETIME LIMITED WARRANTY

QUICK ACCESS FROM THE BEDRAILS

WEATHER GUARD® Lo-Side Boxes mount over the bedrails of your truck and keep critical tools and parts at your fingertips. Their easy installation utilizes mounting brackets that do not require drilling into the rails. The design and location on the truck bed aren't the only attributes that keep you productive—you can get inside with just one hand using an automotive-style latch. The durable Lo-Side is available in steel and diamond plate aluminum protected by an ARMOR TUF® Powder Coat finish. The Lo-Side from WEATHER GUARD® can also be used separately or in combination with Cross Boxes or Saddle Boxes.

ALUMINUM DIAMOND PLATE



Clear ARMOR TUF® Powder Coat



Textured Matte Black ARMOR TUF® Powder Coat



Gloss Black ARMOR TUF® Powder Coat



Gunmetal Gray ARMOR TUF® Powder Coat

STEEL



Brite White ARMOR TUF® Powder Coat



Gloss Black ARMOR TUF® Powder Coat

Choice Options: X = 0 (Clear) or X = 3 (Brite White) or X = 5 (Gloss Black) or X = 52 (Textured Matte Black) or X = 6 (Gunmetal Gray)





41" LOW PROFILE

ALUMINUM 3.0 CUBIC FEET

- 180-0-04 180-52-04
- 180-5-04 180-6-04

Ship Weight: 40.5 Lbs.



41" STANDARD

ALUMINUM 3.0 CUBIC FEET

- 184-0-04 184-52-04
- 184-5-04 184-6-04

Ship Weight: 42 Lbs.

STEEL 3.0 CUBIC FEET

- 185-3-04
- 185-5-04

Ship Weight: 63.5 Lbs.

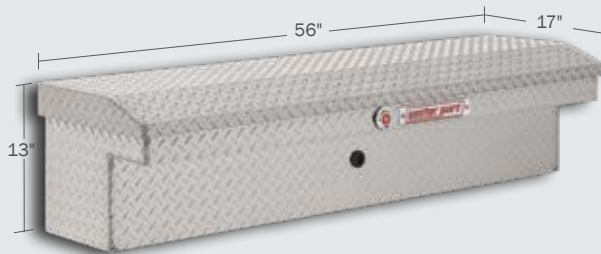

56" LOW PROFILE

ALUMINUM 3.8 CUBIC FEET

- 178-0-04 178-52-04
- 178-5-04 178-6-04

Ship Weight: 49.5 Lbs.



56" STANDARD

ALUMINUM 4.0 CUBIC FEET

- 174-0-04 174-52-04
- 174-5-04 174-6-04

Ship Weight: 49 Lbs.

STEEL 4.0 CUBIC FEET

- 175-3-04
- 175-5-04

Ship Weight: 79.5 Lbs.



87" STANDARD

ALUMINUM 7.0 CUBIC FEET

- 164-0-04 164-52-04
- 164-5-04 164-6-04

Ship Weight: 65.5 Lbs.

STEEL 7.0 CUBIC FEET

- 165-3-04
- 165-5-04

Ship Weight: 114 Lbs.

UNMATCHED PROTECTION HI-SIDE BOXES

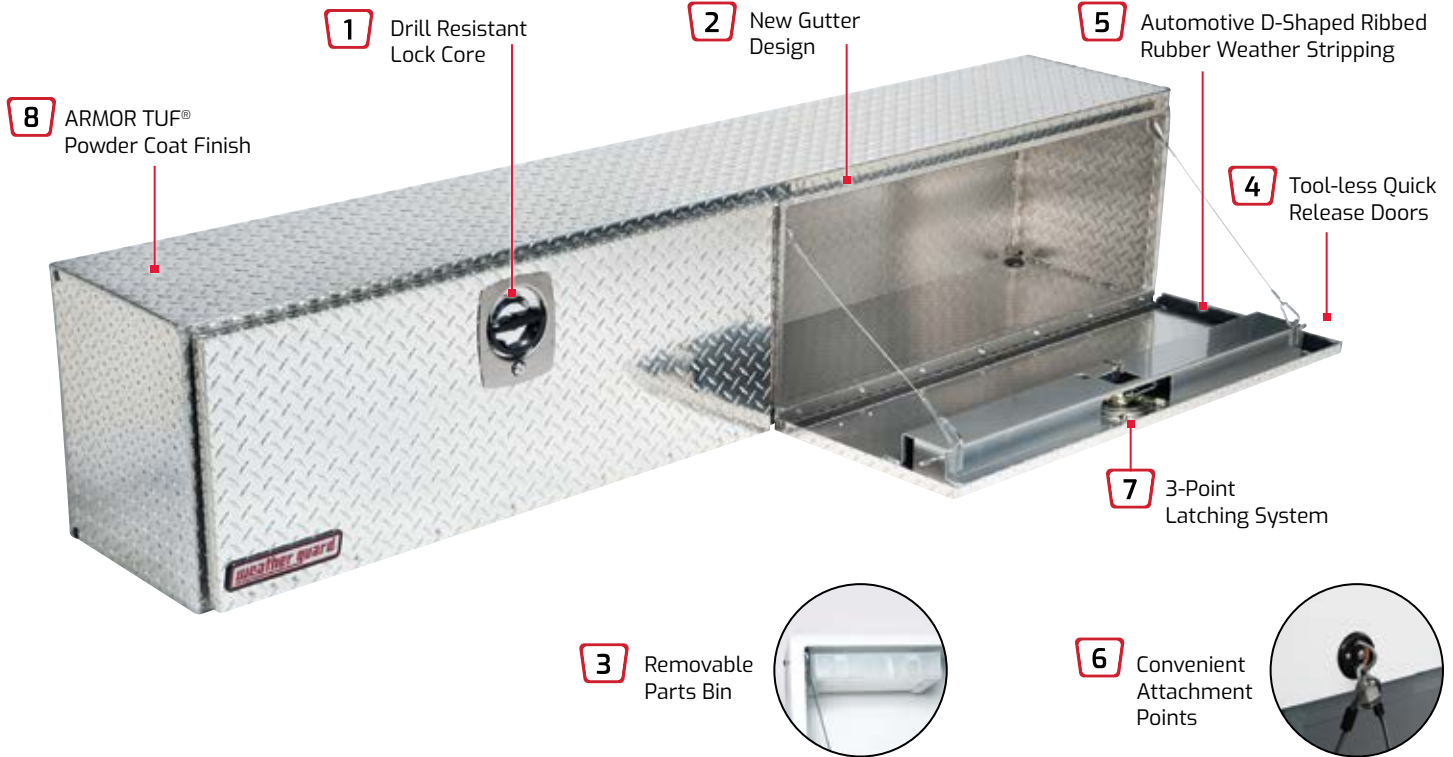

LIFETIME LIMITED WARRANTY

ADDING STORAGE WHILE PRESERVING BED SPACE

Even the best can get better. That's why we keep pushing our engineers to top themselves. And so they have. Now our class-leading WEATHER GUARD® Hi-Side Truck Boxes deliver even greater protection from the elements, from vandalism. WEATHER GUARD® Hi-Sides are built to outlast the competition, just like you—hard-working construction pros, skilled tradespeople, field service and municipal workers who need quick access to valuable tools, equipment and parts while keeping the truck bed open for supplies. You never stop. Neither do we.

WARNING

Hi-Side Boxes cannot be installed to truck racks. Support legs included with box is required for installation.

HI-SIDE
7.9 CUBIC FEET



- ALUMINUM
-  364-0-02
-  364-5-02
- Ship Weight: 60 Lbs.
- Door Opening Measures: 12 3/4" H x 29" W

HI-SIDE BOXES KEY FEATURES

- 1** Drill resistant lock core helps protect against break-ins
- 2** Gutter design channels rain and snow off box to keep contents dry
- 3** Removable parts bin keeps small items organized
- 4** Tool-less quick release doors adjust from 90° to 180° with QuickClips, no tools required
- 5** Automotive D-Shaped Ribbed Rubber Weather Stripping keeps its shape even after years of service
- 6** Convenient attachment point secures materials and tools in pickup bed
- 7** 3-Point Latching System helps protect against theft and weather
- 8** ARMOR TUF® Powder Coat Protection

RECOMMENDED ACCESSORIES

Adjustable Shelf
Accessory (pg. 15)



HI-SIDE
8.9 CUBIC FEET



ALUMINUM
 372-0-02
 372-5-02
Ship Weight: 64 Lbs.
Door Opening Measures:
 12 3/4"H x 33"W

HI-SIDE
8.9 CUBIC FEET



STEEL
 272-3-02
Ship Weight: 109 Lbs.
Door Opening Measures:
 12 3/4"H x 33"W

HI-SIDE
11.1 CUBIC FEET



ALUMINUM
 390-0-02
 390-5-02
Ship Weight: 74 Lbs.
Door Opening Measures:
 12 3/4"H x 42"W

HI-SIDE
11.1 CUBIC FEET



STEEL
 290-3-02
Ship Weight: 129 Lbs.
Door Opening Measures:
 12 3/4"H x 42"W

HI-SIDE
11.8 CUBIC FEET



ALUMINUM
 396-0-02
 396-5-02
Ship Weight: 79 Lbs.
Door Opening Measures:
 12 3/4"H x 45"W

HI-SIDE
11.8 CUBIC FEET



STEEL
 296-3-02
Ship Weight: 136 Lbs.
Door Opening Measures:
 12 3/4"H x 45"W



UNMATCHED PROTECTION SUPER-SIDE BOXES

SUPER-SIZE YOUR STORAGE

Super-Side versions of the WEATHER GUARD® Hi-Side are available—whether you choose the steel or diamond plate aluminum version—with all of the same features that the Hi-Sides offer. A Super-Side version of the steel Hi-Side is available, providing an extra 2 inches of height and 3 inches of depth. A Jumbo Super-Side version of the steel Hi-Side is also available, with 6 more inches of width and 6 more inches of height for a whopping 21.4 cubic feet capacity. An extra-large Super-Side version of the aluminum Hi-Side is available, too, with an extra 2 inches of height and 3 inches of depth.

LIFETIME LIMITED WARRANTY

ALUMINUM DIAMOND PLATE

-  Gloss Black ARMOR TUF® Powder Coat
-  Clear ARMOR TUF® Powder Coat
-  Textured Matte Black ARMOR TUF® Powder Coat

STEEL

-  Brite White ARMOR TUF® Powder Coat

Choice Options:

- X = 0 (Clear) or
- X = 3 (Brite White) or
- X = 5 (Gloss Black) or
- X = 52 (Textured Black)





SUPER-SIDE 10.8 CUBIC FEET



- ALUMINUM**
-  365-0-02
-  365-5-02
- Ship Weight: 65 Lbs.
- STEEL**
-  265-3-02
- Ship Weight: 114 Lbs.
- Door Opening Measures: 14 3/4"H x 29"W

SUPER-SIDE 15.2 CUBIC FEET



- ALUMINUM**
-  391-0-02
-  391-5-02
-  391-52-02
- Ship Weight: 83 Lbs.
- STEEL**
-  291-3-02
- Ship Weight: 147 Lbs.
- Door Opening Measures: 14 3/4"H x 42"W

JUMBO SUPER-SIDE 21.4 CUBIC FEET



- STEEL**
-  297-3-02
- Ship Weight: 174 Lbs.
- Door Opening Measures: 20 3/4"H x 45"W

UNMATCHED PROTECTION GULL WING BOXES

GULL WING BOX KEY FEATURES

- 1** **EXTREME PROTECTION™ LOCK**
tamper-resistant retracting lock helps protect against break-ins
- 2** **Two independent covers**
access from either side of truck
- 3** **Dual Stage Automotive Rotary Latch and Heavy Duty Looped Strikers**
provide extreme security
- 4** **Heavy Duty C-Channel Reinforced Lid Construction**
for maximum durability
- 5** **Automotive D-Shaped Ribbed Rubber Weather Stripping**
keep its shape even after years of service
- 6** **ARMOR TUF® Powder Coat Protection**
- 7** **Heavy Gauge Five Piece Welded Construction**
puts strength where it is needed most



LIFETIME LIMITED WARRANTY

FULL-SIZE STANDARD 11.3 CUBIC FEET

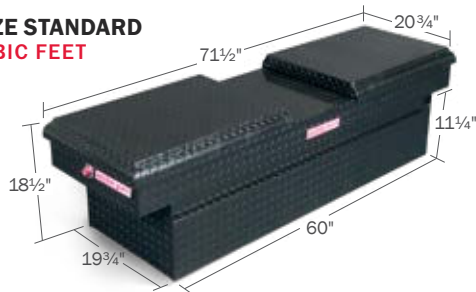

- ALUMINUM**
- 124-0-01
 - 124-5-01
- Ship Weight: 122 Lbs.*

- STEEL**
- 125-3-01
- Ship Weight: 122 Lbs.*

FULL-SIZE EXTRA WIDE 15.3 CUBIC FEET



- ALUMINUM**
- 114-0-01
 - 114-5-01
- Ship Weight: 92 Lbs.*

- STEEL**
- 115-3-01
- Ship Weight: 150 Lbs.*

QUICK ACCESS FROM EITHER SIDE OF THE TRUCK BED

WEATHER GUARD® Gull Wing Boxes allow access from either side of the truck with two independent covers. A productivity-aiding plus is an automotive-style latch that allows you to pop each cover open with one hand. These rugged, versatile boxes are available in steel and aluminum diamond plate protected by the ARMOR TUF® Powder Coat, and a full weather seal keeps out the elements. Gull Wing Boxes can be used in combination with Lo-Side or Super-Lo Boxes for even more storage.

UNMATCHED PROTECTION

ALL PURPOSE CHESTS



ALL PURPOSE CHESTS KEY FEATURES

- 1** **EXTREME PROTECTION™ LOCK**
tamper-resistant retracting lock helps protect against break-ins
- 2** **90° Cover opening**
for easy access
- 3** **Heavy Duty C-Channel Reinforced Lid Construction**
for maximum durability
- 4** **Unique Offset Hinges**
allows chest to lie flat against truck
- 5** **Automotive D-Shaped Ribbed Rubber Weather Stripping**
keeps its shape even after years of service
- 6** **Sliding Steel Tray**
all chests except compact

LIFETIME LIMITED WARRANTY

A LOW-RIDER WORK HORSE

Maximize your visibility with All-Purpose chests that sit below the bedrail, accommodating tonneau covers and lids. An angled body design allows the chest to fit in fifth-wheel trailer configurations. The cover opens to 90° for maximum access using a unique offset hinge design that still allows installation flush against the truck cab. For durability, they're built of steel or diamond plate aluminum and finished with ARMOR TUF® Powder Coat

ALUMINUM DIAMOND PLATE



Clear ARMOR TUF® Powder Coat



Textured Matte Black ARMOR TUF® Powder Coat



Gloss Black ARMOR TUF® Powder Coat



Brite White ARMOR TUF® Powder Coat

STEEL



Brite White ARMOR TUF® Powder Coat





Gloss Black ARMOR TUF® Powder Coat

Choice Options: X = 0 (Clear) or X = 3 (Brite White) or X = 5 (Gloss Black) or X = 52 (Textured Matte Black)







COMPACT
6.0 CUBIC FEET

- ALUMINUM**
-  644-0-01
 -  644-5-01
- Ship Weight: 37 Lbs.*
- STEEL**
-  645-3-01
- Ship Weight: 67 Lbs.*



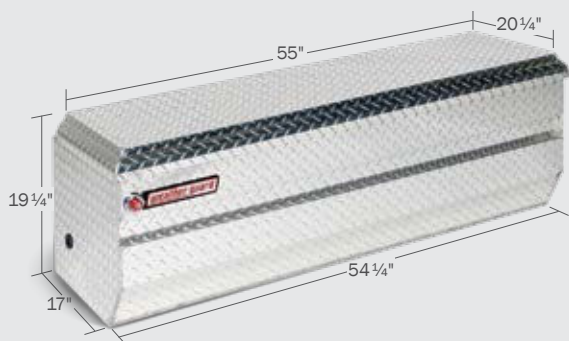

FULL/COMPACT
10.0 CUBIC FEET

- ALUMINUM**
-  674-0-01
 -  674-5-01
 -  674-52-01
- Ship Weight: 43 Lbs.*
- STEEL**
-  675-3-01
- Ship Weight: 80 Lbs.*



FULL/COMPACT
12.0 CUBIC FEET

- ALUMINUM**
-  654-0-01
 -  654-5-01
- Ship Weight: 52 Lbs.*
- STEEL**
-  655-3-01
 -  655-5-01
- Ship Weight: 94 Lbs.*





FULL-SIZE STANDARD
13.1 CUBIC FEET

- ALUMINUM**
-  664-0-01
 -  664-5-01
 -  664-52-01
- Ship Weight: 57 Lbs.*
- STEEL**
-  665-3-01
 -  665-5-01
- Ship Weight: 112 Lbs.*



FULL-SIZE EXTRA WIDE
18.6 CUBIC FEET

- ALUMINUM**
-  684-0-01
 -  684-5-01
- Ship Weight: 71 Lbs.*
- STEEL**
-  685-3-01
- Ship Weight: 134 Lbs.*

UNMATCHED PROTECTION WHEEL WELL BOXES



WHEEL WELL BOX KEY FEATURES

- 1** EXTREME PROTECTION™ LOCK
tamper-resistant retracting lock helps protect against break-ins
- 2** 90° Cover opening
for easy access
- 3** Heavy Duty C-Channel Reinforced Lid Construction
for maximum durability
- 4** Automotive D-Shaped Ribbed Rubber Weather Stripping
keeps its shape even after years of service
- 5** ARMOR TUF®
Powder Coat Protection

LIFETIME LIMITED WARRANTY

MAKING USE OF SPACE AROUND THE WHEEL WELLS

WEATHER GUARD® has figured out a way to make use of otherwise unutilized truck bed space above and behind the wheel wells with these uniquely shaped boxes. They establish a great location for storing small parts and hand tools to which you often need quick, easy access. They're constructed of either steel or aluminum protected with an ARMOR TUF® Powder Coat Wheel Well Boxes leave plenty of room in the truck bed for hauling around your weekend toys.

DRIVER/PASSENGER-SIDE STANDARD

2.1 CUBIC FEET

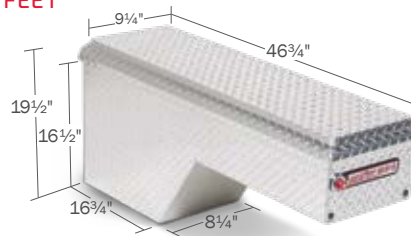

ALUMINUM

170-5-01 (driver)
171-5-01 (passenger)
Ship Weight: 36 Lbs.

STEEL

160-3-01 (driver)
161-3-01 (passenger)
Ship Weight: 53 Lbs.

DRIVER/PASSENGER-SIDE WIDE

3.4 CUBIC FEET

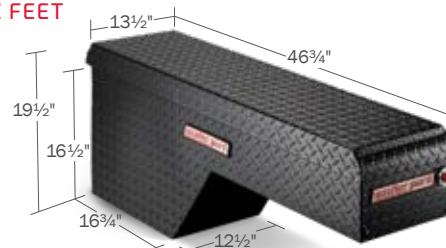

ALUMINUM

172-5-01 (driver)
173-5-01 (passenger)
Ship Weight: 42 Lbs.

TRUCK BOX ACCESSORIES

KEEP YOUR TOOLS AND EQUIPMENT ORGANIZED AND EASY TO ACCESS

STEEL DIVIDER TRAY

617 – 26¹/₂"L x 14"W

Ship Weight: 14 Lbs.

FITS: 114-X-01, 115-X-01, 116-X-04, 117-X-04, 684-X-01, 685-X-01



STEEL DIVIDER TRAY

615 – 19¹/₄"L x 14"W

Ship Weight: 14 Lbs.

FITS: 121-X-04, 123-X-04, 124-X-01, 126-X-04, 127-X-04, 128-X-04, 131-X-04, 136-X-04, 154-X-04, 156-X-04, 654-X-01, 655-X-01, 664-X-01, 665-X-01, 674-X-01, 675-X-01



TRAYS

200-3 – 41¹/₂"L x 9¹/₂"W

Ship Weight: 17 Lbs.

202-3 – 24"L x 9¹/₂"W

Ship Weight: 12 Lbs.

16-gauge steel with adjustable dividers; bolts to back wall of cabinet.



Shown in Hi-Side Box

TRUCK BOX FIT GUIDE

Coating Choice Options: X=0 (Clear) or X=3 (Brite White) or X=5 (Gloss Black) or X=6 (Gunmetal Gray) or X=52 (Textured Black).
 Not all coating choices are available on all models.

			5' BED	6' BED	5½' BED	6½' BED	8' BED	5½' BED	6' BED	8' BED	5' BED	6' BED	5½' BED	6½' BED	8' BED	
			CHEVROLET COLORADO	CHEVROLET SILVERADO 1500/2500/3500			DODGE RAM 1500/2500/3500			FORD RANGER	FORD F150*					
SADDLE BOXES	ALUM	STEEL														
FULL-SIZE EXTRA WIDE		116-X-04			•	•	•	•	•	•				•	•	•
	117-X-04				•	•	•	•	•	•				•	•	•
FULL-SIZE DEEP		128-X-04				•	•			•					•	•
	123-X-04					•	•			•					•	•
FULL-SIZE STANDARD		126-X-04			•	•	•	•	•	•				•	•	•
	127-X-04				•	•	•	•	•	•				•	•	•
FULL-SIZE LOW-PROFILE		120-X-04			•	•	•	• [†]	•	•				•	•	•
	121-X-04				•	•	•	• [†]	•	•				•	•	•
COMPACT - DEEP	137-X-04		•	•							•	•				
COMPACT - STANDARD		156-X-04	•	•							•	•				
	154-X-04		•	•							•	•				
COMPACT - LOW-PROFILE	131-X-04		•	•							•	•				
GULL WING BOXES																
FULL-SIZE EXTRA WIDE		115-3-01			•	•	•	•	•	•				•	•	•
	114-X-01				•	•	•	•	•	•				•	•	•
FULL-SIZE STANDARD		125-X-01			•	•	•	•	•	•				•	•	•
	124-X-01				•	•	•	•	•	•				•	•	•
ALL-PURPOSE CHESTS																
COMPACT		645-X-01	•	•	•	•	•	•	•	•	•	•	•	•	•	•
	644-X-01		•	•	•	•	•	•	•	•	•	•	•	•	•	•
FULL/COMPACT		655-3-01				•	•			•				•	•	
	654-X-01					•	•			•				•	•	
FULL-SIZE STANDARD		665-X-01								•					•	
	664-X-01									•					•	
FULL/COMPACT		675-3-01			•	•	•			•	•			•	•	•
	674-X-01				•	•	•			•	•			•	•	•
FULL-SIZE EXTRA WIDE		685-3-01								•					•	
	684-X-01									•					•	

* Newer truck models available with aluminum beds are compatible with the WEATHER GUARD® truck boxes and chests in the table. Follow installation instructions for mounting to aluminum beds and use mounting components included with the truck box.
 † Does not fit Ram Classic or 2018 & older models



6¾' BED	8' BED	5' BED	6' BED	5½' BED	6½' BED	8' BED	5' BED	6' BED	5½' BED	6½' BED	8' BED	5' BED	6' BED	5½' BED	6½' BED	8' BED
FORD SUPER DUTY F-250/F-350		GMC CANYON		GMC SIERRA 1500/2500/3500			NISSAN FRONTIER		NISSAN TITAN			TOYOTA TACOMA		TOYOTA TUNDRA		
•	•			•	•	•			•	•	•			•	•	•
•	•			•	•	•			•	•	•			•	•	•
•	•				•	•			•	•	•			•	•	•
•	•				•	•			•	•	•			•	•	•
•	•			•	•	•			•	•	•			•	•	•
•	•			•	•	•			•	•	•			•	•	•
•	•			•	•	•			•	•	•			•	•	•
		•	•				•	•								
		•	•				•	•								
		•	•													
		•	•				•	•								

•	•			•	•	•			•	•	•					•
•	•			•	•	•			•	•	•					•
•	•			•	•	•			•	•	•			•	•	•
•	•			•	•	•			•	•	•			•	•	•

•	•	•	•	•	•	•	•	•	•	•	•			•	•	•
•	•	•	•	•	•	•	•	•	•	•	•			•	•	•
•	•				•	•				•	•					•
•	•				•	•				•	•					•
											•					
											•					
•	•			•	•	•			•	•	•				•	•
•	•			•	•	•			•	•	•				•	•
											•					
											•					

NOTE: THIS GUIDE APPLIES TO 2018 OR NEWER MODEL YEAR VEHICLES.
 YOU SHOULD MEASURE YOUR VEHICLE TO MAKE SURE YOUR WEATHER GUARD® TRUCK BOX WILL FIT.

UNMATCHED PROTECTION

ALUMINUM HEADACHE RACK

BED-RAIL MOUNT SOLUTIONS



**LIFETIME LIMITED
WARRANTY**

ALUMINUM HEADACHE RACK

There's only one brand of headache rack worthy of playing wingman to your WEATHER GUARD® truck box. Just as durable and reliable, WEATHER GUARD® headache racks are built to protect your cab and your professional reputation. They come in four classic designs fitting of the professional you are, and most importantly they're equipped with the WEATHER GUARD® badge. The same one on your truck box that proudly states you have tools of your trade worth protecting.

**WHEREVER THE
JOB TAKES YOU,
WE'RE RIGHT
BEHIND YOU.**

- 1 Universal Fit**
Easily installs on full size pickup makes and models
- 2 Durable**
Corrosion-resistant aluminum to protect against even the harshest weather conditions
- 3 Versatility**
Adjusts for roof height or taller for transporting materials

Included parts

- 4 Channel slot for accessories**
Channel to install light brackets and attachment points



ALUMINUM HEADACHE RACK/ ACCESSORIES

OPEN FRAME

11902-52-01

Includes: (1) Rack, (2) Weldment Brackets, (2) Base Brackets, (1) Bolt Kit

66 in x 22 in x 3.6 in



Ship Weight: 31 Lbs.

HALF BAR

11908-52-01

Includes: (1) Rack, (2) Weldment Brackets, (2) Base Brackets, (1) Bolt Kit

66 in x 25.5 in x 3.6 in



Ship Weight: 38.5 Lbs.

HEX

11906-52-01

Includes: (1) Rack, (2) Weldment Brackets, (2) Base Brackets, (1) Bolt Kit

66 in x 25.5 in x 3.6 in



Ship Weight: 43 Lbs.

LOUVERED

11904-52-01

Includes: (1) Rack, (2) Weldment Brackets, (2) Base Brackets, (1) Bolt Kit

66 in x 25.5 in x 3.6 in



Ship Weight: 43 Lbs.

ACCESSORIES

SIDE LIGHT BRACKET

11919-52-01

2 PACK

7.8 in x 3.5 in x 8.0 in

Ship Weight: 4 Lbs.



CENTER LIGHT BRACKET

11920-52-01

24 in x 2.0 in x 8.0 in

Ship Weight: 5 Lbs.



CARGO STOPS

11921-52-01

2 PACK

2.3 in x 6.4 in x 4.2 in

Ship Weight: 2.5 Lbs.



ATTACHMENT POINTS

11922

2 PACK

3.2 in x 2.5 in x 0.5 in

Ship Weight: 1 Lbs.



LEVELING SPACER

11923-52-01

2 PACK

12.8 in x 0.75 in x 2.0 in

Ship Weight: 1.5 Lbs.



UNMATCHED PROTECTION

ALUMINUM HEADACHE RACK FITMENT

BED-RAIL MOUNT SOLUTIONS

PART NUMBER	CHEVROLET COLORADO		CHEVROLET SILVERADO 1500/2500/3500			DODGE RAM 1500/2500/3500			FORD RANGER		FORD F150			FORD SUPER DUTY F-250/F-350	
	5' BED	6' BED	5½' BED	6½' BED	8' BED	5½' BED	6' BED	8' BED	5' BED	6' BED	5½' BED	6½' BED	8' BED	6¾' BED	8' BED
11902-52-01 OPEN FRAME			•	•	•	•	•	•			•	•	•	•	•
11908-52-01 HALF BAR			•	•	•	•	•	•			•	•	•	•	•
11904-52-01 LOUVERED			•	•	•	•	•	•			•	•	•	•	•
11906-52-01 HEX			•	•	•	•	•	•			•	•	•	•	•

PART NUMBER	GMC CANYON		GMC SIERRA 1500/2500/3500			NISSAN FRONTIER		TOYOTA TACOMA	
	5' BED	6' BED	5½' BED	6½' BED	8' BED	5' BED	6' BED	5' BED	6' BED
11902-52-01 OPEN FRAME			•	•	•				
11908-52-01 HALF BAR			•	•	•				
11904-52-01 LOUVERED			•	•	•				
11906-52-01 HEX			•	•	•				



Open Frame



Half Bar



Louvered



Hex

BED-RAIL MOUNT SOLUTIONS STEEL TRUCK RACK

STEEL TRUCK RACK KEY FEATURES

- 1 No-Drill Installation**
Installs in less than an hour (15-20 minutes to assemble/30 minutes to install)
- 2 Welded Airfoil Included**
No need to purchase an accessory, helps deflect wind
- 3 Maximum Tie Down Points**
4 areas allow for additional tie down points on rack legs for items on rack



BED-RAIL MOUNT SOLUTIONS



NO-DRILL INSTALL



WELDED AIRFOIL INCLUDED



MAXIMUM TIE DOWN POINTS

- 3 Models - Compact Standard, Full Size Standard, Full Size Heavy Duty
- 1,000 lb. weight rated (evenly distributed) for standard racks. 1,700 lb. weight rated (evenly distributed) for heavy duty rack
- Compatible with Weather Guard boxes



BED-RAIL MOUNT SOLUTIONS

STEEL TRUCK RACK

FULL SIZE STEEL TRUCK RACK

1275-52-02

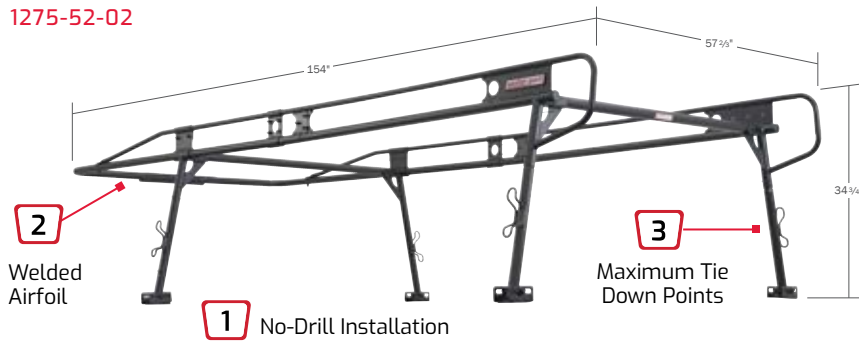

COMPACT STEEL TRUCK RACK

1345-52-02

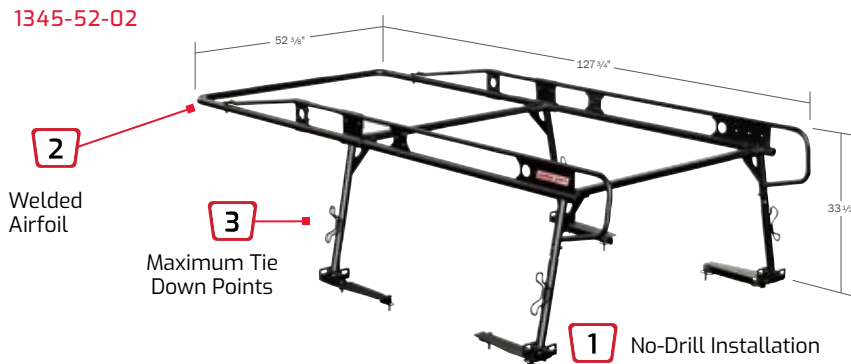

FULL SIZE HEAVY DUTY STEEL TRUCK RACK

1175-52-02

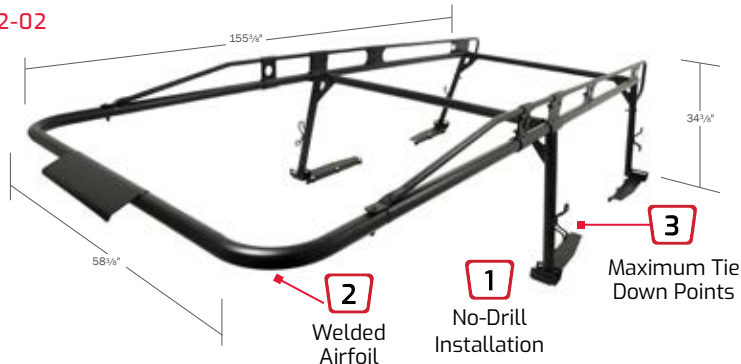

ACCESSORIES

FULL-SIZE CAB PROTECTOR

1059-52-01

Mounting points line up with pre-drilled holes on Full Size Steel Truck Rack Front legs

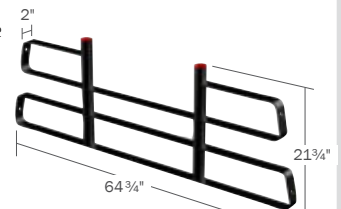

Matte Black Finish
Matches Compact Steel Truck Rack

Ship Weight: 61 Lbs.

COMPACT CAB PROTECTOR

1058-52-01

Mounting points line up with pre-drilled holes on Compact Steel Truck Rack Front legs

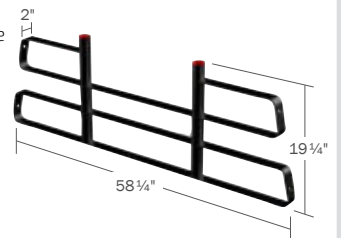

Matte Black Finish
Matches Compact Steel Truck Rack

Ship Weight: 61 Lbs.

FULL-SIZE ACCESSORY CROSS MEMBER

1290-52-01

No-Drill Installation utilizes locking pins (same as rear cross member on rack)



Matte Black Finish
Matches Compact Steel Truck Rack

Ship Weight: 15.5 Lbs.

COMPACT ACCESSORY CROSS MEMBER

1390-52-01

No-Drill Installation utilizes locking pins (same as rear cross member on rack)



Matte Black Finish
Matches Compact Steel Truck Rack

Ship Weight: 9.1 Lbs.

RATCHET STRAPS

1057-52-01

Works with the 1175-52-02, 1275-52-02 & 1345-52-02.



Installation requires product to be drilled into truck rack and is permanently installed to the rack.

Quick release button retracts the straps automatically for easy slowing when not in use.

Straps rated to 1,000 Lbs.

INCLUDES:

Set of 2 ratchet straps, mounting bracket, and mounting hardware

REAR ROLLING CROSS MEMBER

1090-52-01

1091-52-01

1092-52-01

Easily roll ladders and other long items onto the truck rack.

Matte black Finish
No-Drill Installation

Ship Weight: 10.5 lbs.



HEAVY DUTY CROSS MEMBER

1190-52-01

No-Drill Installation utilizes locking pins (same as rear cross member on rack)

Matte Black Finish
Matches Full Size Heavy Duty Steel Truck Rack

Ship Weight: 12.9 Lbs.



BED-RAIL MOUNT SOLUTIONS

STEEL SERVICE BODY RACK

KEY FEATURES

- 1 WEATHER GUARD® Truck Equipment offers the same quality and durability on our Steel Service Body Rack as on our other field-proven racks.

NOTE: Do not mount on aluminum, plastic, fiberglass or top-opening service body trucks. Mount only on steel service bodies.

STEEL SERVICE BODY RACK

LOAD CAPACITY 1000 LBS.

1225

For full-size steel service bodies.

INCLUDES: legs, side rails and cross members.

Ship Weight: 233 Lbs.

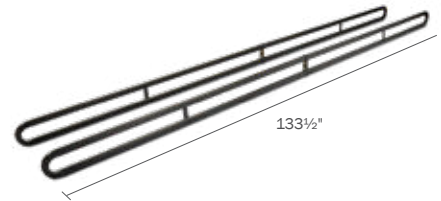

LIFETIME LIMITED WARRANTY

ALUMINUM SERVICE BODY RACK

KEY FEATURES

- 1 The WEATHER GUARD® Aluminum Service Body Rack is designed to make loading or unloading a ladder a "one-person" job.
- 2 Front post adjusts in height and swivels to allow for easy positioning of ladder during removal or placement
- 3 Both posts have a wide mounting

NOTE: Do not mount on an aluminum plastic or fiberglass service body. Mount on steel service body only.

ALUMINUM SERVICE BODY RACK

LOAD CAPACITY 200 LBS.

1425-3

For full-size and compact service body trucks on both driver and passenger sides.

Front post adjusts 21 $\frac{3}{8}$ "-35 $\frac{3}{8}$ "

Rear post is stationary at 21 $\frac{3}{8}$ " (shown left)

Front post adjusts 16"-30"

Rear post is stationary at 16 $\frac{1}{4}$ " (shown right)

Ship Weight: 22 Lbs.

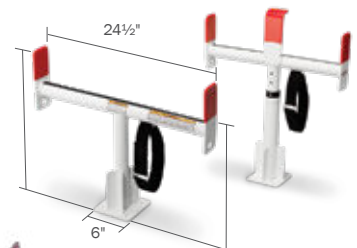

ACCESSORIES

ALUMINUM CONDUIT CARRIER

Keep your conduit safe, secure and clean with our lightweight and durable Conduit Carrier.

237

Conduit Carrier

Ship Weight: 40 Lbs.

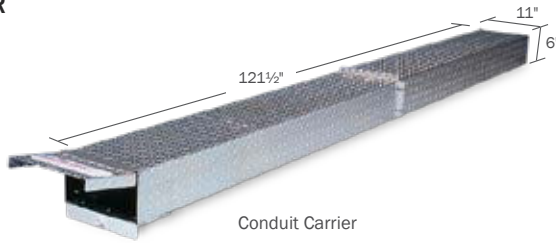

Conduit Carrier

238

6" Extension

Ship Weight: 4 Lbs.

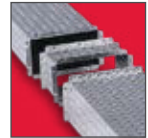

6" Extension

MAKE-YOUR-OWN CONDUIT CARRIER

239

PVC not included. Separately purchase a section of standard 6" PVC (9ASTM D2665) plastic drain pipe.

Coordinate the length of the PVC with the length of conduit you'll be carrying.



Ship Weight: 4 Lbs.

BED-RAIL MOUNT SOLUTIONS WEEKENDER® TRUCK RACK

KEY FEATURES

- 1 Easy on, easy off for that occasional need to carry a ladder or long material.
- 2 Uprights should be removed when not in use.
- 3 Adjustable, tubular steel pockets bolt into the side of the truck bed.
- 4 A set-screw holds the upright in place.
- 5 Load bar is adjustable to accommodate the varied widths of ladders.
- 6 Constructed of 1½" x 1½", 14-gauge wall steel tubing.
- 7 Joints are fully arc-welded.
- 8 Mounting bracket allows WEEKENDER® Truck Rack to be installed on driver side or curb side of truck.

If installing to an aluminum bed, please purchase the 70322 Aluminum Upfit Kit.



BED-RAIL MOUNT SOLUTIONS

**LIFETIME LIMITED
WARRANTY**

HORIZONTAL LOAD CAPACITY 250 LBS.

1450
For '95 and newer pickups, Chevy,
Dodge, Ford and Toyota Tundra.
Ship Weight: 56 Lbs.



TRUCK RACK FIT GUIDE

BED-RAIL MOUNT SOLUTIONS

			TRUCK RACKS			
			1450	1175-52-02	1275-52-02	1345-52-02
BRAND	MODEL	BED LENGTH	WEEKENDER HORIZONTAL RACK	HEAVY DUTY FULL SIZE STEEL TRUCK RACK - 1700 LB. WEIGHT CAPACITY	FULL SIZE STEEL TRUCK RACK - 1000 LB. WEIGHT CAPACITY	COMPACT STEEL TRUCK RACK - 1000 LB. WEIGHT CAPACITY
CHEVROLET	COLORADO	5'				•
CHEVROLET	COLORADO	6'				•
CHEVROLET	SILVERADO 1500	5-1/2'			•	
CHEVROLET	SILVERADO 1500	6'			•	
CHEVROLET	SILVERADO 1500	8'			•	
CHEVROLET	SILVERADO 2500/3500	6'		•	•	
CHEVROLET	SILVERADO 2500/3500	8'		•	•	
DODGE RAM	1500	5-1/2'	•		•	
DODGE RAM	1500	6'	•		•	
DODGE RAM	1500	8'	•		•	
DODGE RAM	2500/3500	6'	•	•	•	
DODGE RAM	2500/3500	8'	•	•	•	
FORD	RANGER	5'	•			•
FORD	RANGER	6'	•			•
FORD	F-150	5-1/2'	•		•	
FORD	F-150	6'	•		•	
FORD	F-150	8'	•		•	
FORD	SUPER DUTY	6-1/2'	•	•	•	
FORD	SUPER DUTY	8'	•	•	•	
GMC	CANYON	5'				•
GMC	CANYON	6'				•
GMC	SIERRA 1500	5-1/2'			•	
GMC	SIERRA 1500	6'			•	
GMC	SIERRA 1500	8'			•	
GMC	SIERRA 2500/3500	6'		•	•	
GMC	SIERRA 2500/3500	8'		•	•	
NISSAN	FRONTIER	4-1/2'				•
NISSAN	FRONTIER	6'				•
NISSAN	TITAN	5-1/2'			•	
NISSAN	TITAN	6-1/2'			•	
TOYOTA	TACOMA	5'				
TOYOTA	TACOMA	6'				
TOYOTA	TUNDRA	6'	•		•	
TOYOTA	TUNDRA	8'	•		•	

PROTECT-A-RAIL®

STEEL CAB PROTECTORS/ACCESSORIES

FOR FULL-SIZE PICKUPS

1908

Heavy-duty cab protector.
(Requires separate purchase of Installation Kit.)

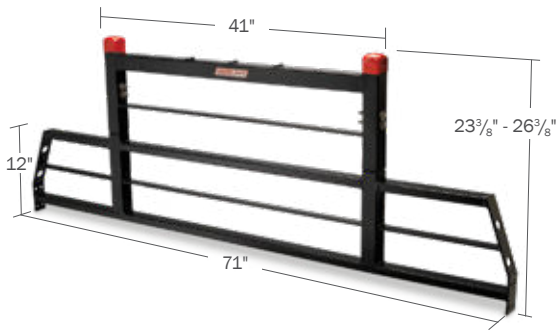

Ship Weight: 46 Lbs.

FOR FULL-SIZE PICKUPS

1906-3-02 (white)

1906-5-02 (black)

Punched steel screen cab protector.
(Requires separate purchase of Installation Kit.)

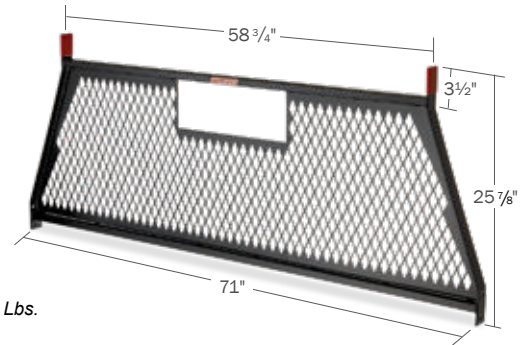

Ship Weight: 33 Lbs.

BED-RAIL MOUNT SOLUTIONS

ACCESSORIES FOR MOUNTING WARNING LIGHTS & LADDERS FOR 1908

1920

9 1/2" x 17" rectangular base.

Ship Weight: 6 Lbs.



1919

7 1/2" side mount round base.

Ship Weight: 3 Lbs.



INSTALLATION KITS FOR FULL SIZE TRUCKS

MODEL	INNER BED WIDTH DIMENSIONS	COLOR
1912-3-02	61.5" - 62.0"	White
1912-5-02	61.5" - 62.0"	Black
1913-3-02	62.0" - 62.5"	White
1913-5-02	62.0" - 62.5"	Black
1915-3-02	62.5" - 63.0"	White
1915-5-02	62.5" - 63.0"	Black
1916-3-02	63" - 63.5"	White
1916-5-02	63" - 63.5"	Black
1921-3-02	63.5" - 64.0"	White
1921-5-02	63.5" - 64"	Black
1925-3-02	65" - 65.5"	White
1925-5-02	65" - 65.5"	Black



INSTALLATION KITS FOR COMPACT TRUCKS

MODEL	FITMENT	COLOR
1927-5-01	Chevy Colorado	Black
	GMC Canyon	Black

IN-BED STORAGE PACK RAT® DRAWER UNITS

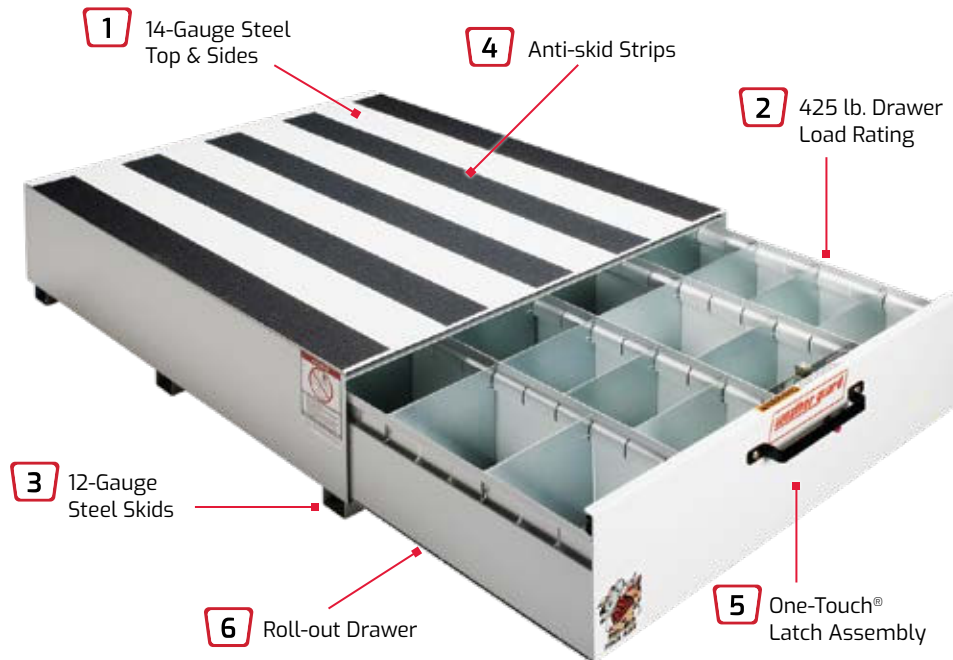

PACK RAT® DRAWER UNIT KEY FEATURES

- 1** 14-Gauge steel top and sides allows 750 Lb. load rating
- 2** Drawer load rating 425 Lbs. evenly distributed
- 3** 12-Gauge steel skids for extra strength
- 4** Anti-skid strips provide traction for work boots
- 5** One-Touch® latch assembly easy, one-hand operation
- 6** Roll-out drawer easy access and organization
- 7** Limited Lifetime Warranty unparalleled quality

LIFETIME LIMITED WARRANTY

HEAVY-DUTY STORAGE KEEPS BED SPACE OPEN AND YOU ORGANIZED

The Heavy-Duty PACK RAT® drawer units can be mounted inside the rear of the vehicle and give you easy access to large tools and supplies while leaving floor space open. These rugged units are constructed of 14-gauge steel on the top and sides, giving you a 750 pound load rating and placing them among the sturdiest items in the back of your truck.

STANDARD DRAWER UNIT 305-3

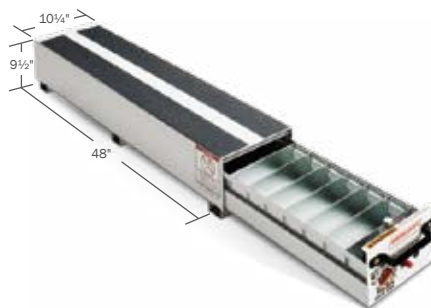

**1 COMPARTMENTS,
6 DIVIDERS.**

Each Drawer Compartment: 5"H x 9 3/4"W x 45"L

Ship Weight: 106 Lbs.

STANDARD DRAWER UNIT 306-3

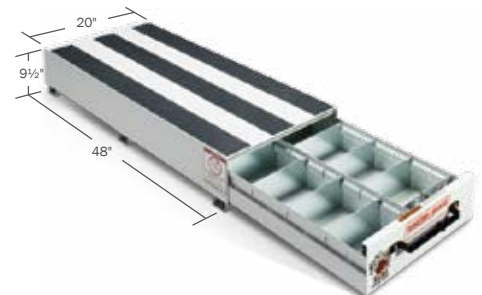

**2 COMPARTMENTS,
12 DIVIDERS.**

Each Drawer Compartment: 5"H x 9 3/4"W x 45"L

Ship Weight: 179 Lbs.

IN-BED STORAGE PACK RAT® DRAWER UNITS

STANDARD DRAWER UNIT 307-3

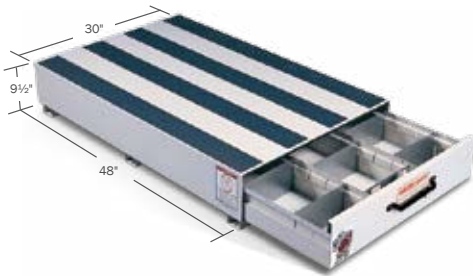

**3 COMPARTMENTS,
18 DIVIDERS.**

Each Drawer Compartment: 5"H x 9¾"W x 45"L

Ship Weight: 247 Lbs.

STANDARD DRAWER UNIT 308-3 (white) 308-5 (black)



**4 COMPARTMENTS,
24 DIVIDERS.**

Each Drawer Compartment: 5"H x 9¾"W x 45"L

Ship Weight: 322 Lbs.

STANDARD DRAWER UNIT 335-3

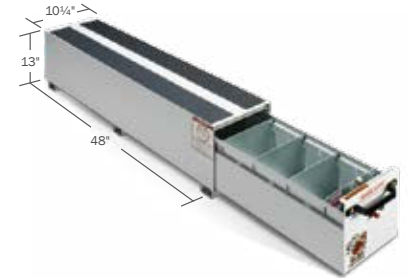

**1 COMPARTMENT,
6 DIVIDERS.**

Each Drawer Compartment: 8½"H x 9¾"W x 45"L

Ship Weight: 130 Lbs.

STANDARD DRAWER UNIT 336-3

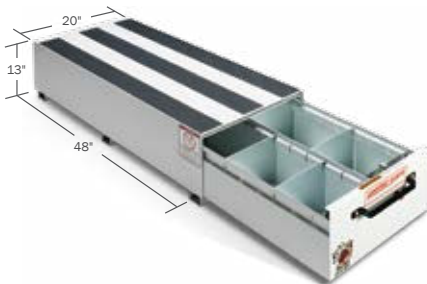

**2 COMPARTMENTS,
12 DIVIDERS.**

Each Drawer Compartment: 8½"H x 9¾"W x 45"L

Ship Weight: 210 Lbs.

STANDARD DRAWER UNIT 337-3

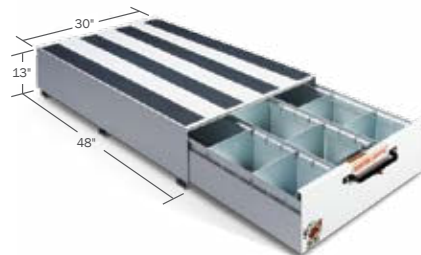

**3 COMPARTMENTS,
18 DIVIDERS.**

Each Drawer Compartment: 8½"H x 9¾"W x 45"L

Ship Weight: 294 Lbs.

STANDARD DRAWER UNIT 338-3 (white) 338-5 (black)



**4 COMPARTMENTS,
24 DIVIDERS.**

Each Drawer Compartment: 8½"H x 9¾"W x 45"L

Ship Weight: 383 Lbs.

IN-BED STORAGE TRANSFER TANKS

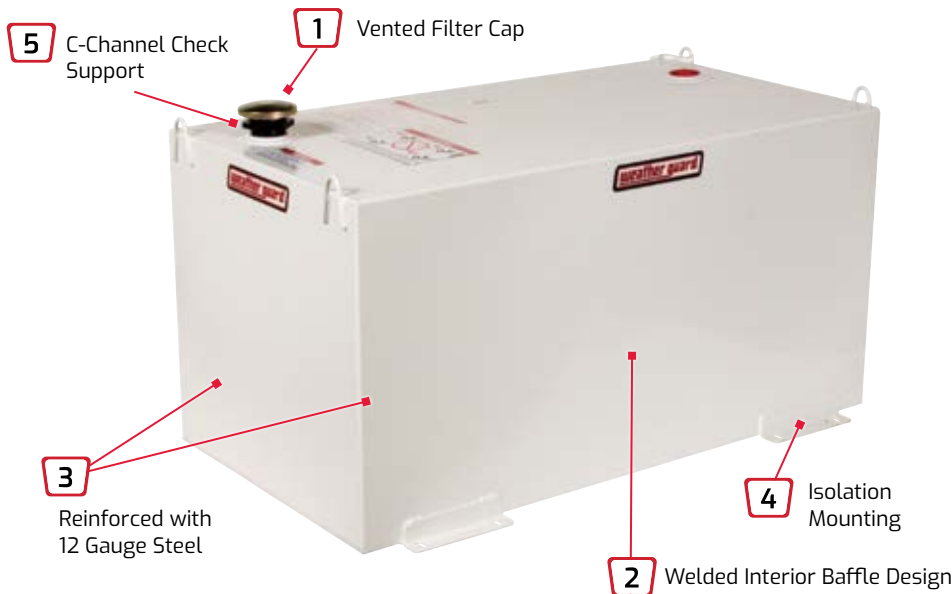

TRANSFER TANK KEY FEATURES

- 1** Vented filler cap
prevents excessive pressure build-up
- 2** Welded Interior Baffle Design
reduces fuel movement
- 3** Reinforced with 12 gauge steel
except 359 model does not require reinforcement for optimal performance
- 4** Isolation mounting reduces road vibration
unparalleled quality
- 5** C-channel check support
for trouble-free operation
- 6** Limited Lifetime Warranty
for peace of mind

**LIFETIME LIMITED
WARRANTY**

FOR TRANSPORTING DIESEL FUEL

WEATHER GUARD® Transfer tanks offer a safer mode of transporting diesel fuel to your jobsite and beyond. L-shaped tanks are designed to be used with Gull Wing Boxes and Saddle Boxes only; rectangular tanks are designed for full-size pickup trucks. Ranging in capacity from 50-110 gallons, WEATHER GUARD® Transfer Tanks feature full arc-welded, heavy 14-gauge steel construction for long-lasting durability. The interior baffle design reduces fuel movement and provides extra tank reinforcement. The lockable vented filler cap prevents excessive pressure build-up and the threaded filler neck accepts standard 2" threaded pipe. Installation is easy using the heavy-duty lifting loops and secure plate-steel flange bed mounting points. All tanks are protected with Brite White or Gloss Black ARMOR TUF® Powder Coat Finish for years of durability, and backed by a Limited Lifetime Warranty.

STEEL TRANSFER TANK 50 GAL. CAPACITY

-  350-3-02
-  350-5-02



For compact pickups. May be used in combination with WEATHER GUARD® Gull Wing and Saddle Boxes.

Product Weight: 122 Lbs. Ship Weight: 132 Lbs.

STEEL TRANSFER TANK 75 GAL. CAPACITY

-  352-3-02
-  352-5-02





For full-size short-bed pickups. May be used in combination with WEATHER GUARD® Gull Wing and Saddle Boxes.

Product Weight: 168 Lbs. Ship Weight: 180 Lbs.

IN-BED STORAGE TRANSFER TANKS

STEEL TRANSFER TANK 90 GAL. CAPACITY

-  354-3-02
-  354-5-02



For full-size pickups. May be used in combination with WEATHER GUARD® Gull Wing and Saddle Boxes.
Product Weight: 196 Lbs. Ship Weight: 208 Lbs.



STEEL TRANSFER TANK 100 GAL. CAPACITY

-  358-3-02
-  358-5-02



For full-size pickups.
Product Weight: 168 Lbs. Ship Weight: 178 Lbs.

STEEL TRANSFER TANK 85 GAL. CAPACITY

-  359-3-02
-  359-5-02

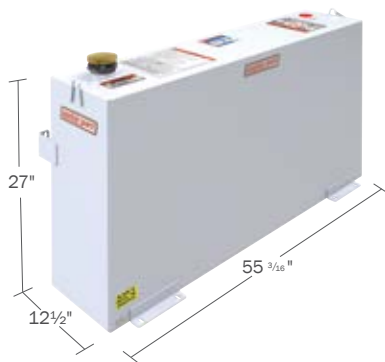

Designed for most full-size pickups.
Product Weight: 124 Lbs. Ship Weight: 136 Lbs.

STEEL TRANSFER TANK 110 GAL. CAPACITY

-  362-3-02
-  362-5-02



For full-size pickups. May be used in combination with WEATHER GUARD® Gull Wing and Saddle Boxes.
Product Weight: 220 Lbs. Ship Weight: 234 Lbs.

UNDERBED STORAGE STEEL UNDERBED BOXES

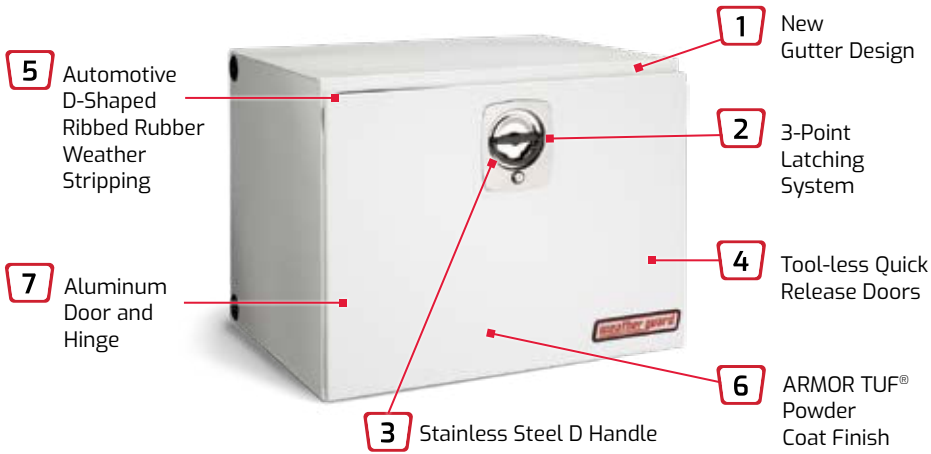

STEEL UNDERBED BOX KEY FEATURES

- 1** Gutter design & weather stripping *easy and positive door closure that protects against the elements*
- 2** 3-point latching system *for optimum security and weather resistance*
- 3** Stainless Steel D Handle *for easy and positive door closure, and added protection against break-ins*
- 4** Tool-less quick release drop down door *full and easy access, adjusts from 90° to 180°*
- 5** Automotive D-Shaped Ribbed Rubber Weather Stripping *keeps its shape even after years of service*
- 6** ARMOR TUF® Powder Coat Protection
- 7** ALUMINUM DOOR and hinge

WIDE SELECTION OF SIZES FOR YOUR NEEDS

WEATHER GUARD® Steel Underbed Boxes come in three size groupings: compact, standard and jumbo. A Brite White or Gloss Black ARMOR TUF® Powder Coat enhances the durability of these boxes' heavy-gauge steel. Steel Underbed Boxes are supplied with an aluminum door and hinge for superior resistance to rust and corrosion.

LIFETIME LIMITED WARRANTY

COMPACT UNDERBED



2.3 CUBIC FEET

525-5-02
Ship Weight: 45 Lbs.
Door Opening Measures:
10 1/2"H x 22 1/2"W

STANDARD UNDERBED



4.5 CUBIC FEET

524-5-02
Ship Weight: 45 Lbs.
(24 1/2"L x 18 1/4"W x 18 1/8"H)
Door Opening Measures:
14 1/2"H x 22 1/2"W

5.6 CUBIC FEET

530-5-02
Ship Weight: 70 Lbs.
(30 1/2"L x 18 1/4"W x 18 1/8"H)
Door Opening Measures:
14 1/2"H x 28 1/2"W

6.7 CUBIC FEET

536-5-02 (Shown)
Ship Weight: 82 Lbs.
Door Opening Measures:
14 1/2"H x 34 1/4"W

9.1 CUBIC FEET

548-5-02
Ship Weight: 100 Lbs.
(48 1/2"L x 18 1/4"W x 18 1/8"H)
Door Opening Measures:
14 1/2"H x 46 1/4"W

11.2 CUBIC FEET

560-5-02
Ship Weight: 135 Lbs.
(60 1/2"L x 18 1/4"W x 18 1/8"H)
Door Opening Measures:
14 1/2"H x 58 1/4"W

JUMBO UNDERBED

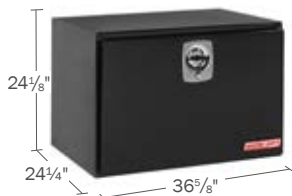

12.1 CUBIC FEET

538-5-02
Ship Weight: 111 Lbs.
(36 5/8"L x 24 1/4"W x 24 7/8"H)
Door Opening Measures:
20 1/2"H x 34 1/4"W

16.2 CUBIC FEET

550-5-02
Ship Weight: 145 Lbs.
(48 1/2"L x 24 1/4"W x 24 7/8"H)
Door Opening Measures:
20 1/2"H x 46 1/4"W

20.2 CUBIC FEET

562-5-02
Ship Weight: 181 Lbs.
(60 1/2"L x 24 1/4"W x 24 7/8"H)
Door Opening Measures:
20 1/2"H x 58 1/4"W

ALUMINUM UNDERBED BOXES

ALUMINUM UNDERBED BOX KEY FEATURES

- 1** Gutter design & weather stripping easy and positive door closure that protects against the elements
- 2** 3-point latching system for optimum security and weather resistance
- 3** Stainless Steel D Handle for easy and positive door closure, and added protection against break-ins
- 4** Tool-less quick release drop down door Full and easy access, adjusts from 90° to 180°
- 5** Automotive D-Shaped Ribbed Rubber Weather Stripping keeps its shape even after years of service
- 6** ARMOR TUF® Powder Coat Protection

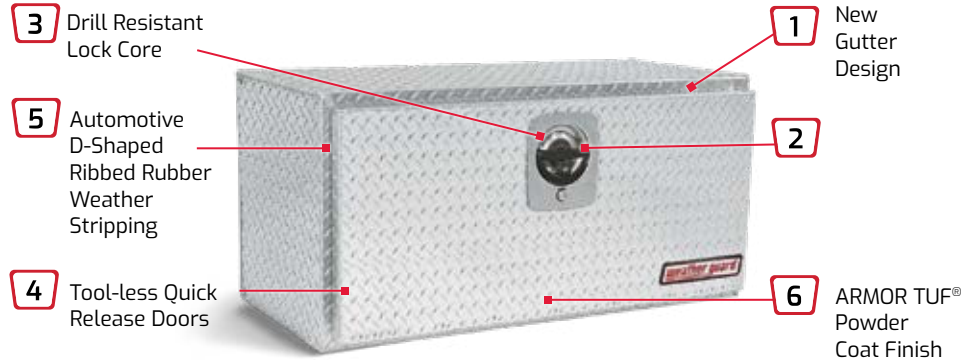

DURABILITY AT LIGHTER WEIGHT

WEATHER GUARD® Aluminum Underbed Boxes are available in compact, standard and jumbo versions to meet your specific needs. Clear or Gloss Black ARMOR TUF® Powder Coat finishes extend the ruggedness of the diamond plate aluminum.



TOOL-LESS QUICK RELEASE DROP DOWN DOOR



WEATHER STRIPPING protects contents from the weather.



STAINLESS STEEL D HANDLE With Drill-resistant Lock Core

LIFETIME LIMITED WARRANTY

STANDARD UNDERBED

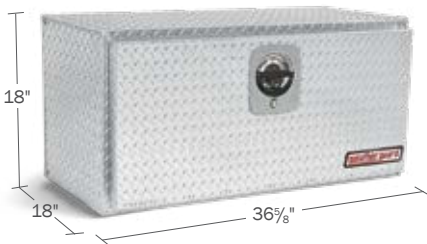

4.3 CUBIC FEET

627-0-02

Ship Weight: 35 Lbs.
(24 1/8" L x 18 1/4" W x 18" H)

Door Opening Measures:
13 1/2" H x 19 1/4" W

5.4 CUBIC FEET

631-0-02
631-5-02

Ship Weight: 42 Lbs.
(30 1/8" L x 18" W x 18" H)

Door Opening Measures:
13 1/2" H x 25 1/4" W

6.5 CUBIC FEET

636-0-02 (Shown)
636-5-02

Ship Weight: 47 Lbs.
(36 1/8" L x 18" W x 18" H)

Door Opening Measures:
13 1/2" H x 34 1/4" W

8.6 CUBIC FEET

648-0-02
648-5-02

Ship Weight: 62 Lbs.
(48 1/8" L x 18" W x 18" H)

Door Opening Measures:
13 1/2" H x 43 1/4" W

11.2 CUBIC FEET

660-0-02
660-5-02

Ship Weight: 135 Lbs.
(60 1/8" L x 18" W x 18" H)

Door Opening Measures:
13 1/2" H x 55 1/4" W

JUMBO UNDERBED



12.2 CUBIC FEET

638-0-02

Ship Weight: 65 Lbs.
(36 1/8" L x 24" W x 24" H)

Door Opening Measures:
19 1/2" H x 31 3/4" W

16 CUBIC FEET

650-0-02

Ship Weight: 81 Lbs.
(48 1/8" L x 24" W x 24" H)

Door Opening Measures:
19 1/2" H x 43 1/4" W

20 CUBIC FEET

662-0-02 (Shown)

Ship Weight: 100 Lbs.
(60 1/8" L x 24" W x 24" H)

Door Opening Measures:
19 1/2" H x 55 1/4" W



SECURE EVERY CHALLENGE

INDUSTRY-LEADING SECURITY

UNMATCHED DURABILITY & RELIABILITY

MAXIMUM ORGANIZATION & PRODUCTIVITY



LIMITED LIFETIME WARRANTY

WERNER CO. (the Manufacturer) warrants to the original purchaser, only, that WEATHER GUARD® truck products (the "WEATHER GUARD Product") will be free from defects in material and workmanship from the date of purchase and continuing for the expected lifetime of the WEATHER GUARD Product. This warranty applies to all WEATHER GUARD product except E-LINE® and Defender Series. Please call our customer service department toll free at 1.800.456.7865 with any questions or comments.

DO NOT use these products for storing or transporting flammables, explosives, hazardous materials or waste, such as gasoline, solvents, gun powder, dynamite, gases or any tanks, torches or gas powered equipment. These products are intended and safe for storing and transporting small tools and other non-combustible, non-flammable materials. Any modification made to, or unintended use of, these products may create a dangerous condition causing death, serious bodily injury or property damage.

NOTICE

Any modification or unintended use of these products shall immediately void all manufacturers warranties. Manufacturer disclaims all liability for injuries to persons or property resulting from any modification to, or unintended use of these products.

For U.S. Terms and Conditions of Sale please reference form number 78-1117. For Canada Terms and Conditions of Sale please reference form number 78-1145.

FOR MORE INFORMATION:

US - visit WEATHERGUARD.COM or call 800.456.7865

CANADA - visit WEATHERGUARD.CA or call 888.562.2251

